

**FORD:**

1996-1999 Taurus SHO  
 1998-2006 Crown Victoria, Mustang  
 2000 Taurus  
 2002-2005 Thunderbird  
 2003-2006 Focus  
 2004-2006 Taurus  
 2005-2006 Five Hundred, Freestyle  
 1997-2006 E-Series, Expedition, F-150  
 1999-2006 F-Super Duty  
 2000-2005 Excursion, F-53  
 2001-2006 Escape  
 2002-2005 Explorer  
 2005-2006 Escape Hybrid

**LINCOLN:**

1997-1998 Mark VIII

1998-2002 Continental  
 1998-2006 Town Car  
 2000-2006 LS  
 1998-2006 Navigator  
 2002-2003 Blackwood  
 2003-2005 Aviator

**MERCURY:**

1998-2006 Grand Marquis  
 2000 Sable  
 2004-2005 Sable  
 2005-2006 Montego  
 2002-2005 Mountaineer  
 2005-2006 Mariner  
 2006 Mariner Hybrid

This article supersedes TSB **04-16-01** to update the vehicle applications and model years.

**NOTE**

FOLLOW THIS TSB PROCEDURE ONLY IF THERE ARE NO SPECIFIC MISFIRE TSBs/SSMs RELEASED FOR THE VEHICLE SYMPTOM BEING EXPERIENCED.

**ISSUE**

Approximately 50% of coil on plug (COP) coils returned for warranty do not have a problem.

**ACTION**

The misfiring cylinder must be identified through Self-Test misfire codes or through WDS Power Balance. Rule out base engine problems, rule out fuel problems, and then look at ignition problems (be sure to rule out coil primary circuit issues). Once the above steps have been completed, and the issue is in the secondary part of the ignition system, the oscilloscope procedure outlined in this TSB can isolate the difference between a coil or spark plug problem.

**SERVICE PROCEDURE**

The optional WDS COP Kit available through Rotunda will provide more accurate diagnosis and help reduce replacement of non-defective parts. The Kit (418-FS528) can be purchased through 1-800-ROTUNDA.

The following material will detail the diagnostic steps on WDS to take the guesswork out of misfire diagnosis using the COP Kit. The following procedure is for cylinder specific misfires and not random misfires. Random misfires have a different root cause and are not covered by this TSB.

**Misfire Definition:** A misfiring cylinder is lacking power relative to the other cylinders. The causes for a cylinder specific misfire could be fuel, spark, or mechanical problems.

Perform a thorough visual inspection. If no visible concerns are found use the following WDS tools for misfire diagnosis:

- Self-test (Check for codes first)
- Power Balance (Identify the cylinder of concern)

**NOTE:** The information in Technical Service Bulletins is intended for use by trained, professional technicians with the knowledge, tools, and equipment to do the job properly and safely. It informs these technicians of conditions that may occur on some vehicles, or provides information that could assist in proper vehicle service. The procedures should not be performed by "do-it-yourselfers". Do not assume that a condition described affects your car or truck. Contact a Ford, Lincoln, or Mercury dealership to determine whether the Bulletin applies to your vehicle. Warranty Policy and Extended Service Plan documentation determine Warranty and/or Extended Service Plan coverage unless stated otherwise in the TSB article. The information in this Technical Service Bulletin (TSB) was current at the time of printing. Ford Motor Company reserves the right to supersede this information with updates. The most recent information is available through Ford Motor Company's on-line technical resources.

- Relative Compression (Rule out a possible mechanical issue)
- Fuel (Make sure fuel injectors are not restricted)
- Ignition (Make sure spark plugs and coils are working properly)
- Oscilloscope (Detailed signal analysis)

### **NOTE**

USE THE ENCYCLOPEDIA BUTTON IN THE LOWER LEFT CORNER OF THE SCREEN FOR DETAILED INFORMATION ON THE WDS TOOL BEING DISPLAYED.

If there is a self-test code identifying a particular cylinder then you just need to determine if it is a fuel, ignition, or possibly a mechanical problem. Proceed to Step 2 after running Relative Compression to rule out any mechanical issues. If there is no self-test code and the customer concern is a miss, proceed to Step 1.

### **Step 1: (Select Toolbox Icon, then Powertrain, then Power Balance)**

The cylinder specific miss has to be identified as shown in the example in Figure 2 in order to proceed with the remaining steps. If the miss does not occur at idle (in the bay), try to brake torque the engine. This extra loading should reproduce the miss in the bay. If the miss cannot be reproduced during brake torque, select Relative Compression under Powertrain on WDS before going on a road test to rule out mechanical problems. If Relative Compression shows a problem then the base engine issue must be serviced. If Relative Compression results are good (Figure 3), road test under as many different driving conditions as possible until the miss occurs on Power Balance. Some misses may be very intermittent so be patient and concentrate on steady load conditions. Once a cylinder dropout is identified proceed to Step 2.

### **Step 2: (Select Toolbox Icon, then Powertrain, then Fuel System Test)**

Run Fuel System Test on WDS to determine if there may be a fuel problem. After completing fuel Pressure/Leakdown test, select Injector flow to isolate a restricted injector as shown in Figure 4. If all the injectors are within specification, proceed to Step 3.

### **Step 3: (Select Toolbox Icon, then Powertrain, then Ignition System Test)**

Run Ignition System Test on WDS to determine if there is an ignition problem. Look at both duration (DUR) and kilovolts (KV) and look for values that stand out from the rest as shown in Figure 5 and Figure 6.

### **NOTE**

LIVE DISPLAY HAS TO AVERAGE IGNITION VALUES BECAUSE THERE IS TOO MUCH DATA TO DISPLAY. MAKE A CAPTURE TO VIEW EACH ENGINE EVENT WITHOUT AVERAGING. THIS CAN BE HELPFUL WHEN THE PROBLEM IS INTERMITTENT. IF THE MISS IS EXTREMELY INTERMITTENT AND DOES NOT SHOW UP IN IGNITION, PROCEED TO STEP 4.

If either spark duration or peak KV on the Red Probe (Suspect Cylinder) are offset from the values displayed on the Black Probe (Known Good Cylinder) then the problem is in the ignition system. Rule out coil primary circuit issues before proceeding to coil secondary issues such as the spark plug, coil boot, or possibly the coil. Use the WDS Oscilloscope with the COP kit to determine if the issue is the coil or the spark plug.

### **Step 4: (Select Toolbox, then Oscilloscope)**

### **WARNING**

**SECONDARY IGNITION VOLTAGES ARE VERY HIGH. KEEP HANDS AND TOOLS AWAY FROM THE END OF THE COIL THAT SUPPLIES THE SPARK.**

**SET-UP:** With the engine off, pull the suspect coil from the cylinder well and turn it upside down so the coil cannot spark to any other surface as shown in Figure 1. Wrap a clean shop cloth around the hard shell of the coil to help keep the coil propped up and stable.

## TSB 05-22-8 (Continued)

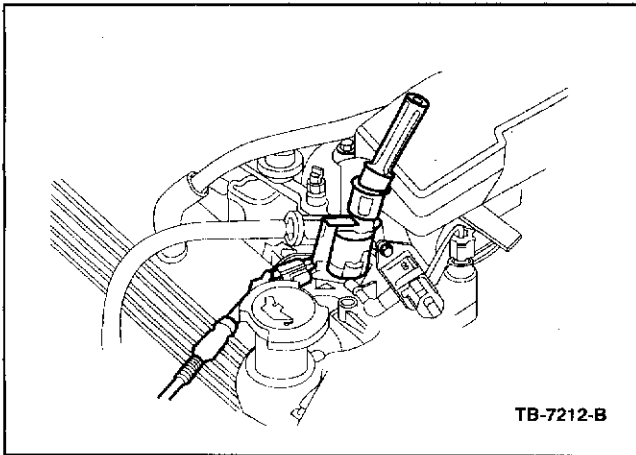

Figure 1 - Article 05-22-8

### **CAUTION**

**THE COIL BOOT CAN BE DAMAGED IF THE COIL SPARKS TO ANOTHER SURFACE DURING THIS PROCEDURE.**

Keep the coil connected to the harness and leave the WDS COP clip attached to the coil. Route the coil clip wire and cable away from the coil being tested as well as other coils to avoid noise interference. Disconnect the injector of the cylinder being tested so raw fuel is not washing the cylinder. This is a stress test for the coil. The type of waveform displayed on the oscilloscope will show whether a coil or the plug is the problem if all previous steps have been followed. Keep hands and tools away from the end of the coil that supplies the spark.

### **COP Stress Test Procedure:**

Go to the Oscilloscope Tool and select Channel 3, then select Auto, then select COP\_STRESS\_TEST\_RED. This pre-configured setting will zoom-in on the peak firing of the coil being tested. Start the engine and be sure the coil is not sparking to any surface. If the coil is sparking to other surfaces, turn the engine off immediately and readjust the coil so it cannot spark to any other surface. Restart the engine and touch the Red Man icon to start the oscilloscope. All settings are pre-configured and no adjustments are necessary. Compare the waveform you get with the examples provided in Figures 7, 8, and 9). Figure 7 is a good waveform. If your waveform is similar to Figure 7 the coil is working correctly. Suspect the spark plug.

Figure 8 and Figure 9 are examples of problem coils. Replace the coil if the waveform is similar to Figures 8 or 9. The coil is causing the misfire when the peak firing appears like those shown in Figures 8 and 9. Notice the difference in the peak-firing signal when compared to the good peak signal in Figure 7.

Figure 9 shows a more dramatic fault in the peak failure.

Most root causes of misfire issues can be identified quickly using the steps outlined above. Some misfire issues can be difficult making the oscilloscope an important part of your diagnostic toolbox.

**OTHER APPLICABLE ARTICLES:** 05-13-4

**WARRANTY STATUS:** Eligible Under Provisions Of  
New Vehicle Limited  
Warranty Coverage

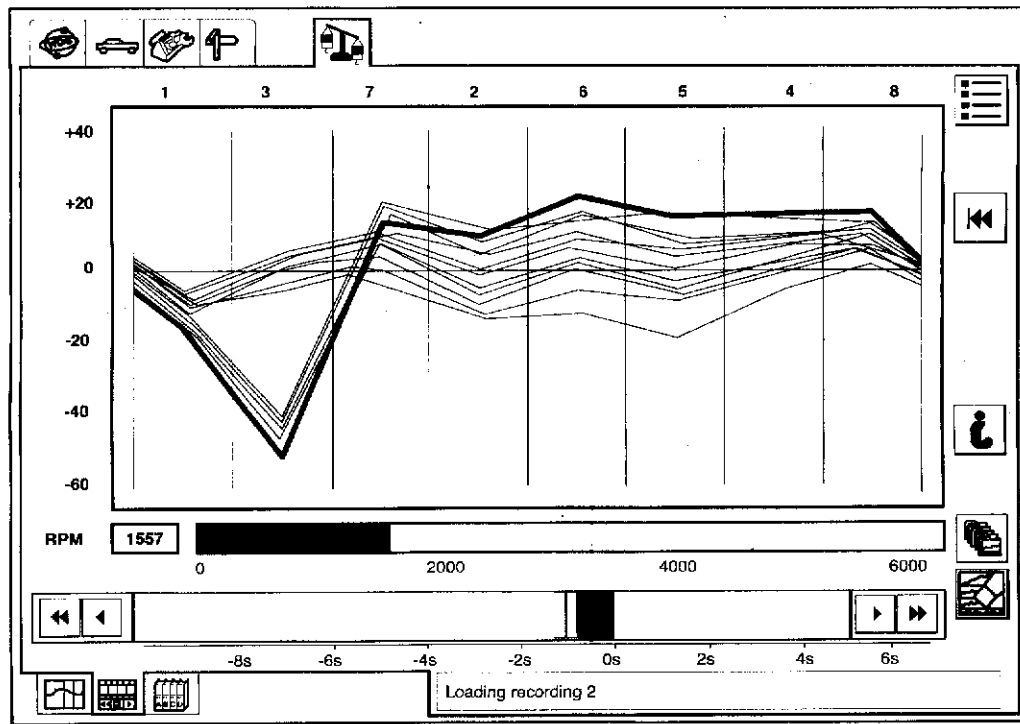

TB-7026-C

Figure 2 - Article 05-22-8

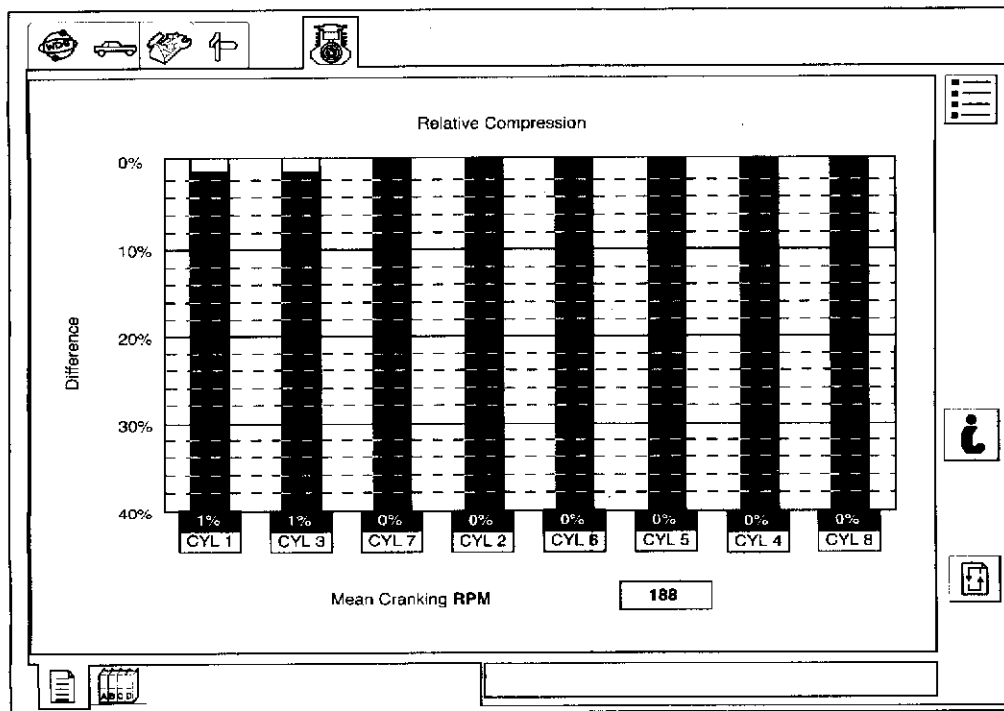

TB-7211-C

Figure 3 - Article 05-22-8

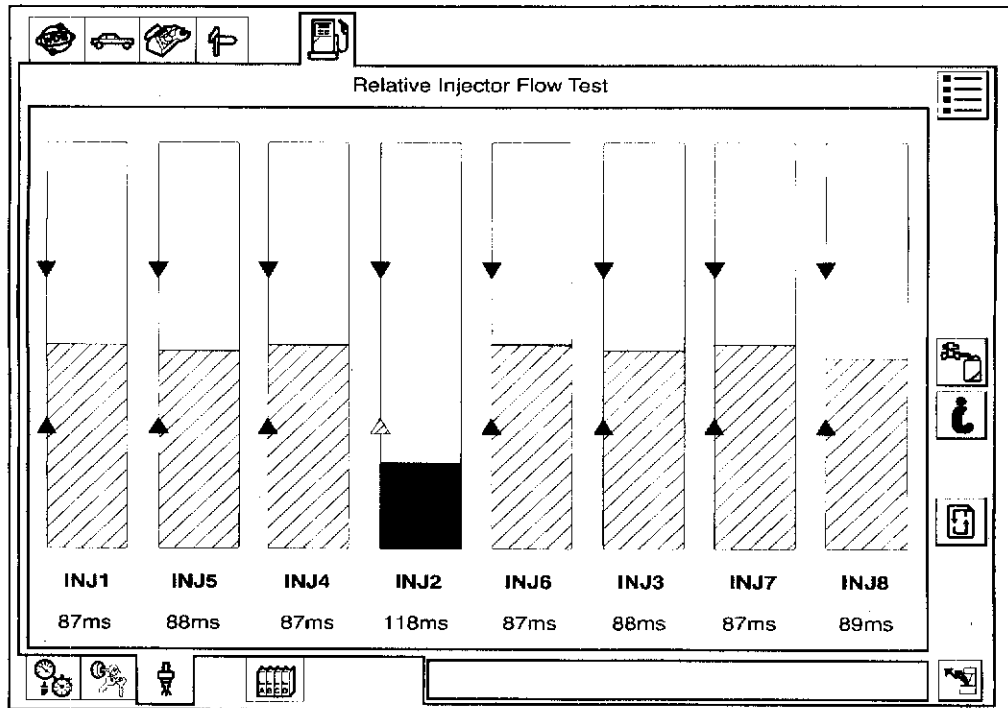

TB-7027-C

Figure 4 - Article 05-22-8

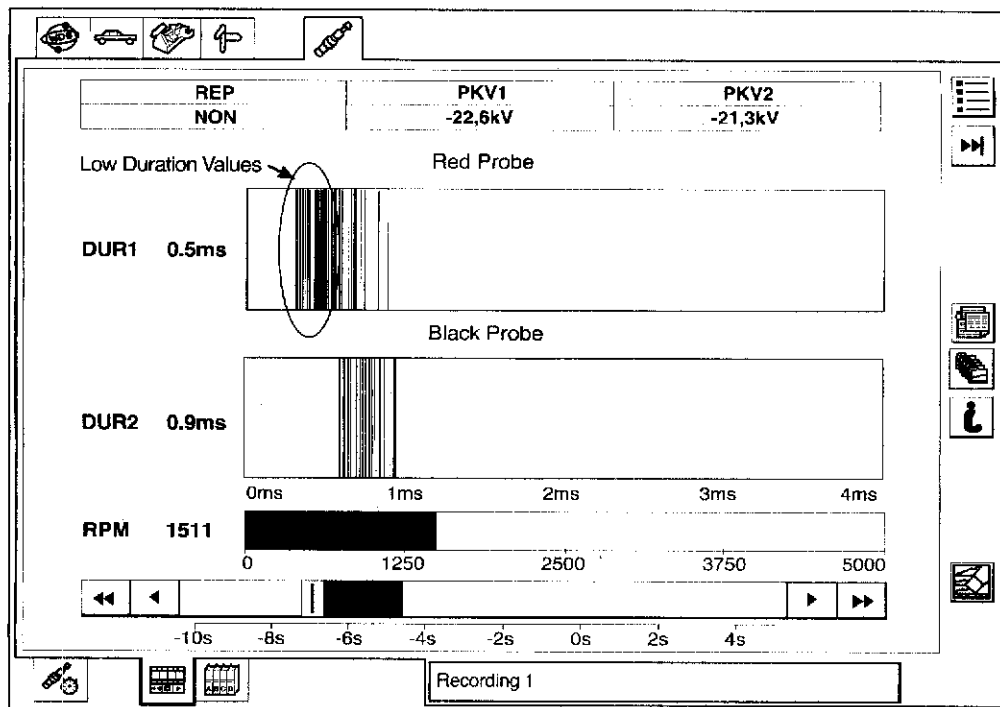

TB-7028-C

Figure 5 - Article 05-22-8

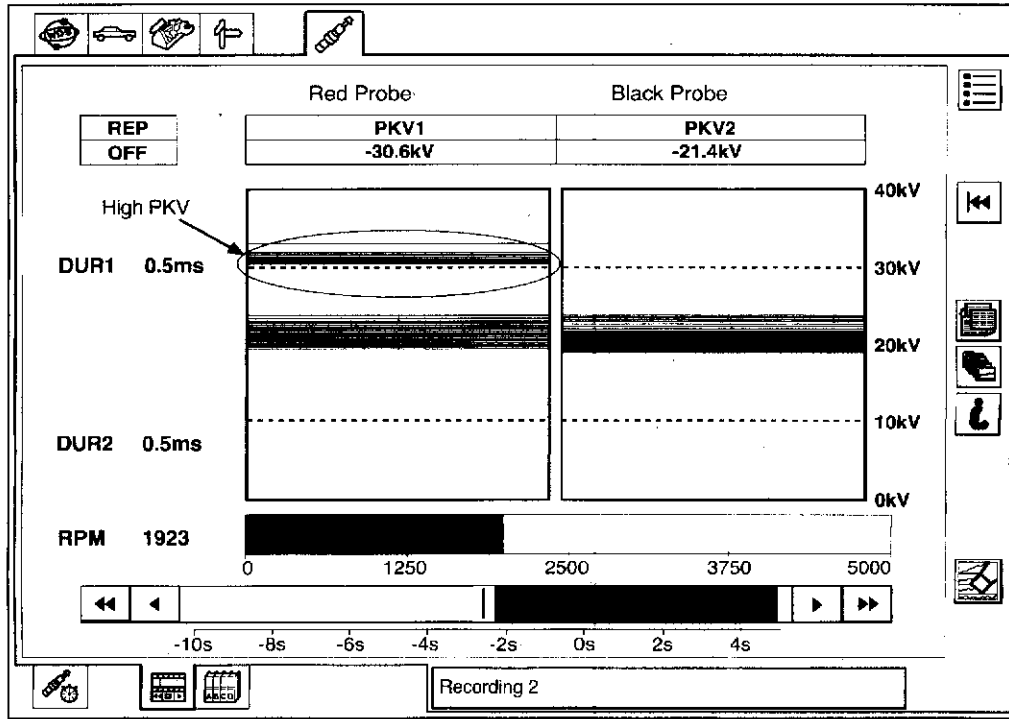

Figure 6 - Article 05-22-8

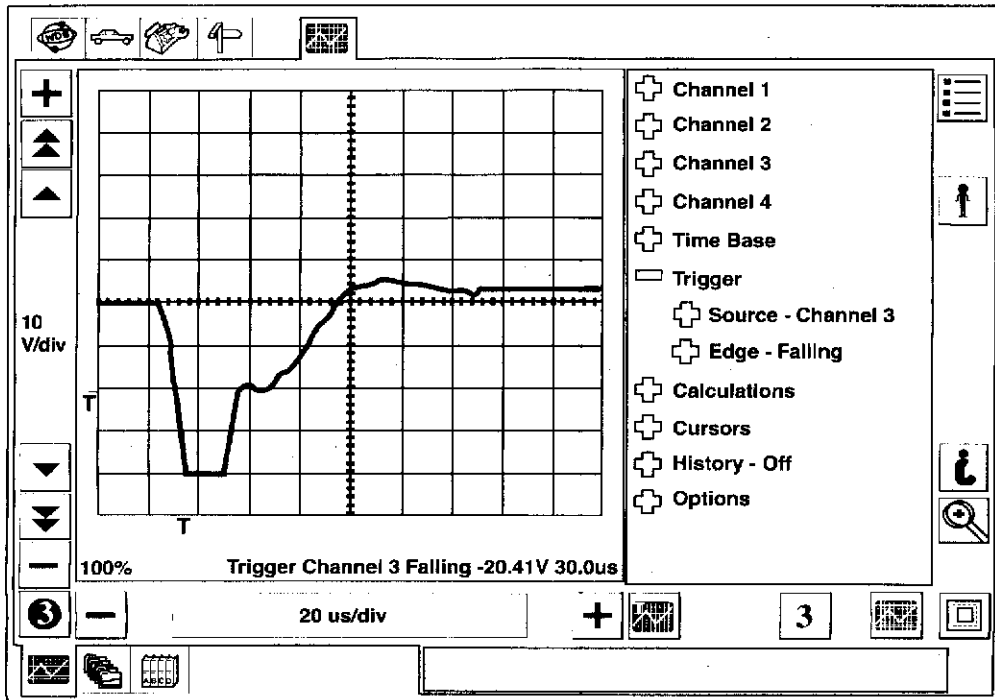
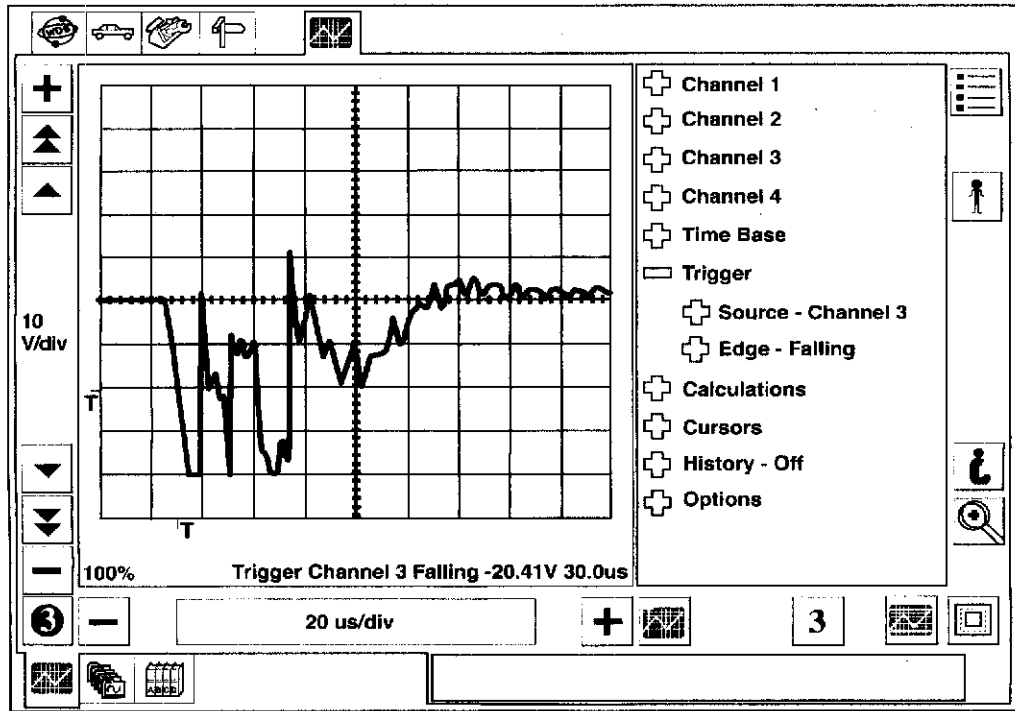
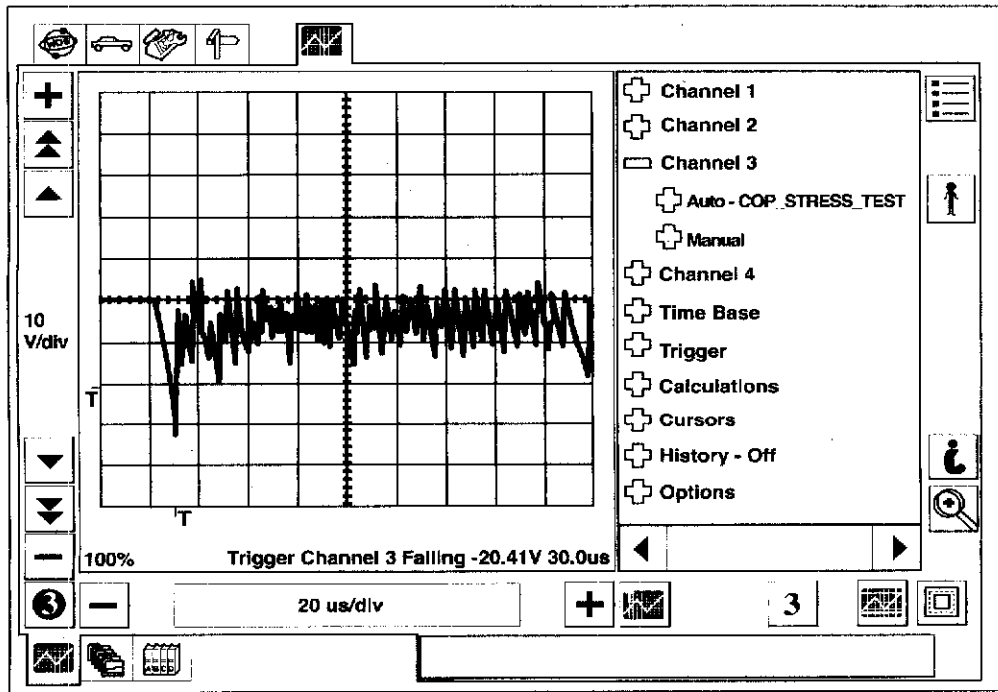

Figure 7 - Article 05-22-8



TB-7031-C

Figure 8 - Article 05-22-8



TB-7032-C

Figure 9 - Article 05-22-8